

Prehľad Prehľad

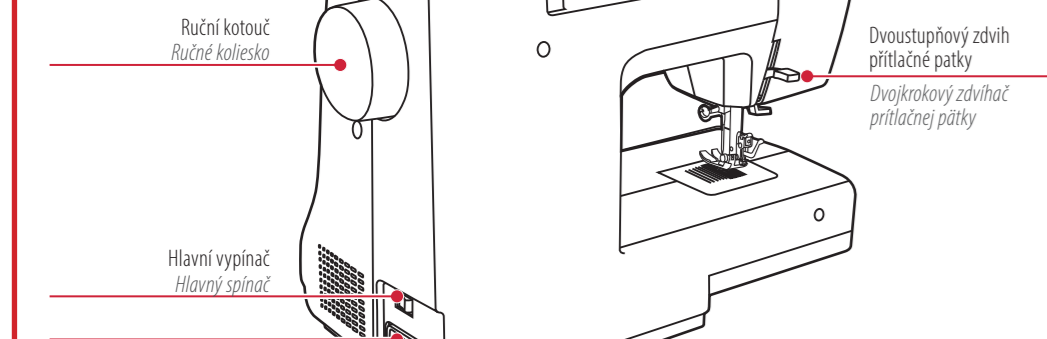
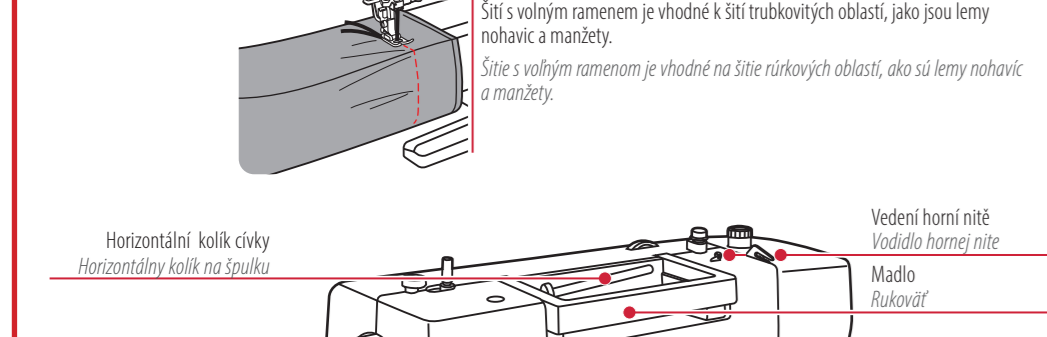
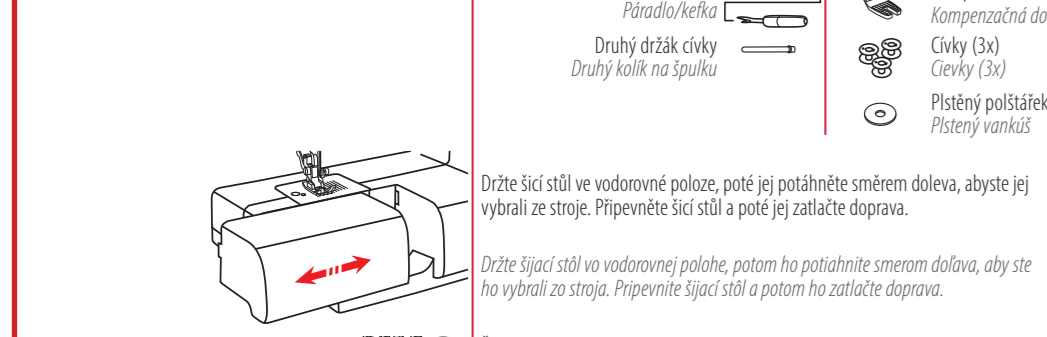
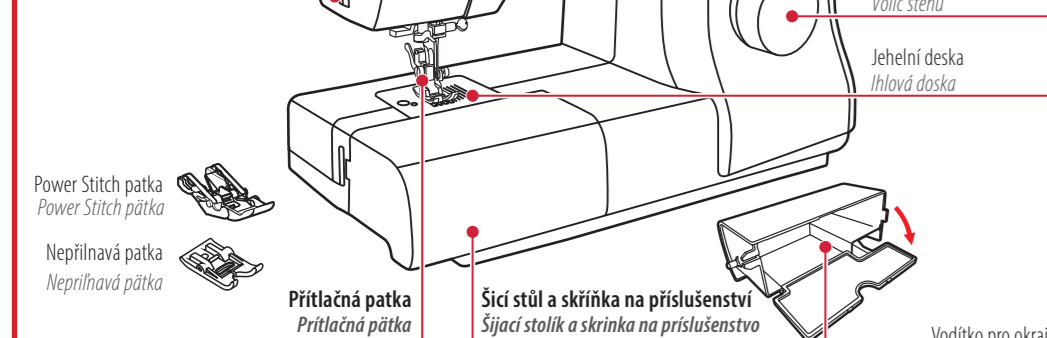
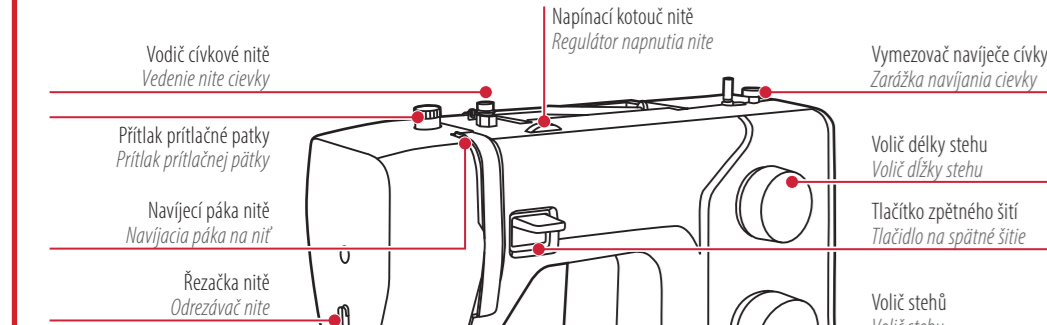

Šití Šití

Pred šitím se uistite, že ste dodrželi kombinace jehla/látka/nit' a použili navrženou přítlačnou patku.
Przed szyciem sa upewnij, że ste dodrželi kombinację igły/látka/nit' a použili navrhnutú prítlačnú patku.

Prud šitím sa uistite, že ste dodrželi kombinácie ihla/látka/nit' a použili navrhnutú prítlačnú patku.

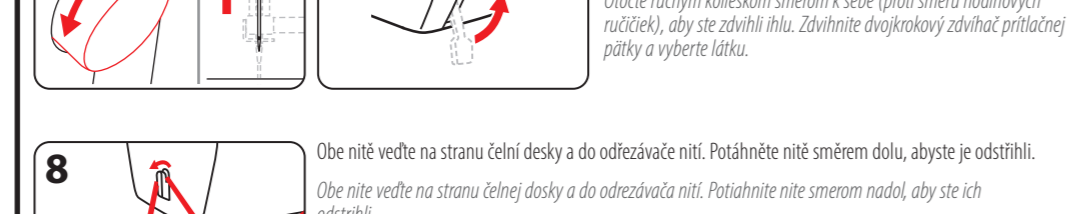
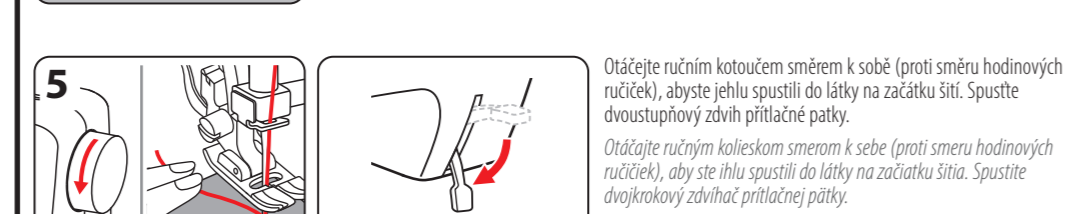
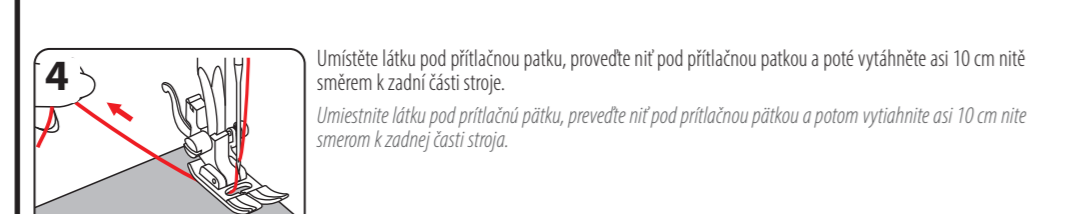
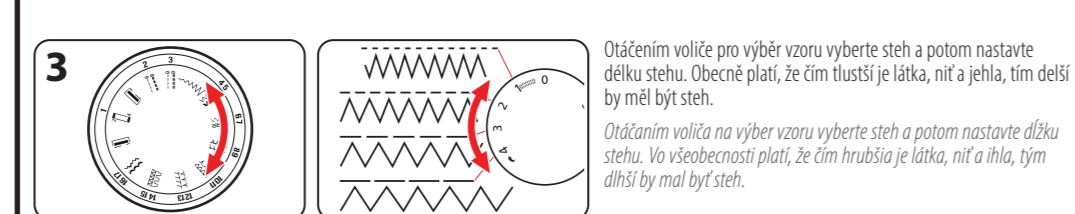
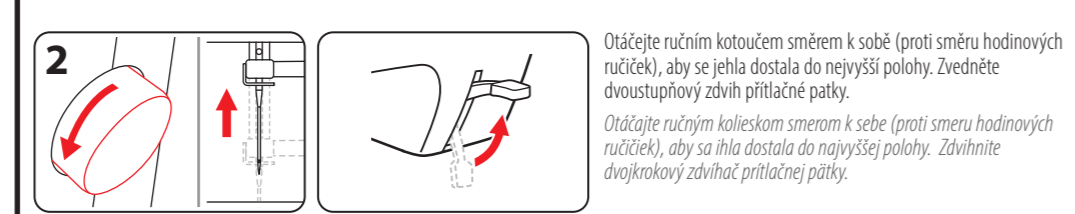
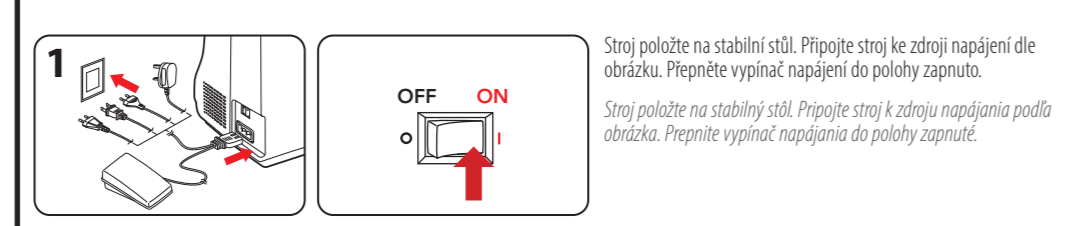

Nasazení jehly Vkladanie ihly

Jehlu pravidelně vyměňujte, především pokud vykazuje známky opotřebení anebo pokud způsobuje problémy. Při vykonávání níže uvedených operací přepněte vypínač napájení do polohy vypnuto ("O")!
Ihlu pravidelne vymieňajte, najmä ak vykazuje známky opotrebovania alebo ak spôsobuje problémy. Pri vykonávaní nižšie uvedených operácií prepnite vypínač napájania do polohy vypnuté ("O")!

Prí vykonávaní nižšie uvedených operácií vypnite vypínač napájania! Vždy používajte správnu patku pro vybraný vzor. Nesprávna patka může způsobit zlomení jehly.

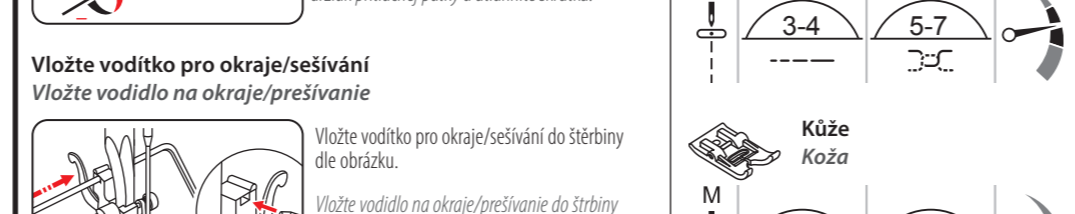
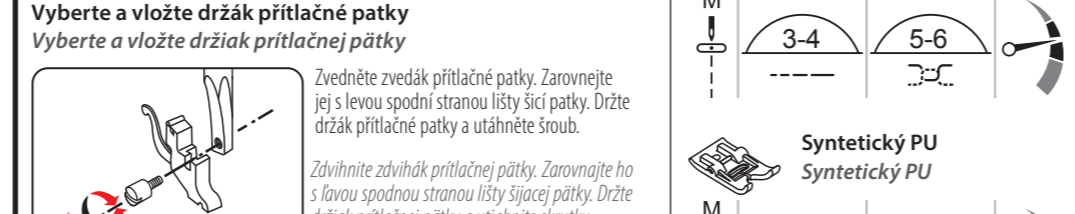
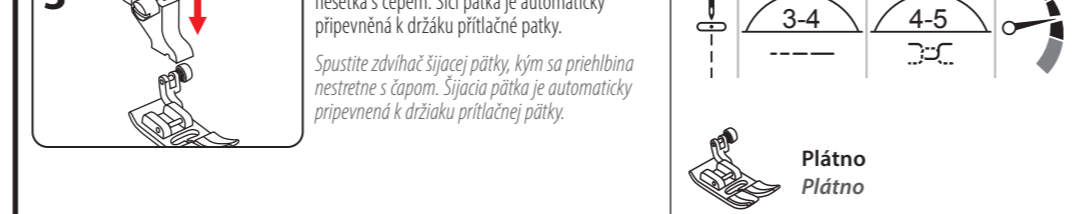
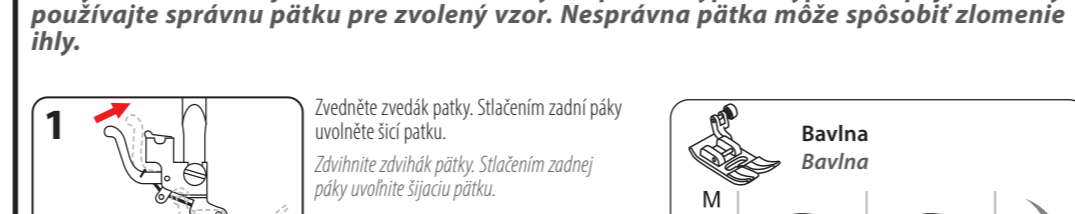
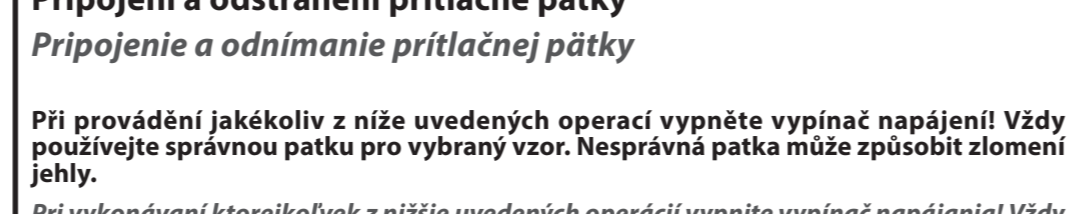
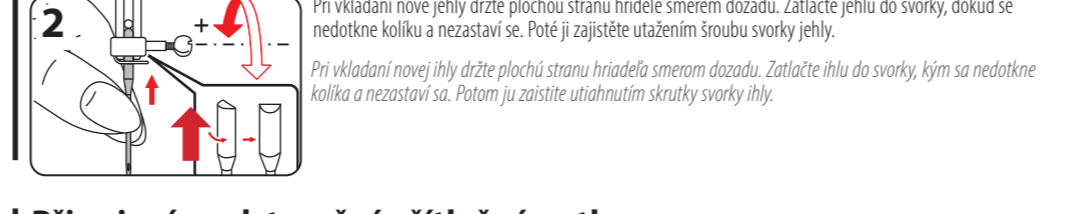
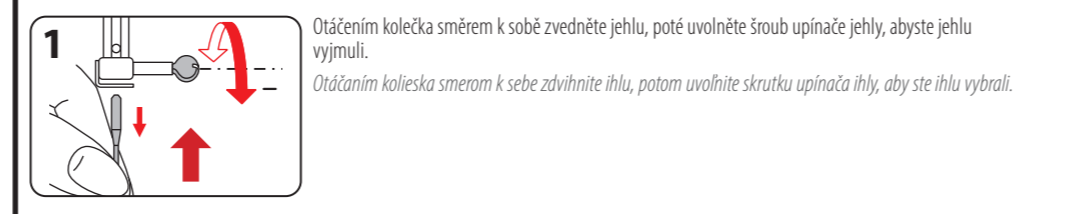

Navinutí a vložení cívky Navinutie a vloženie cievky

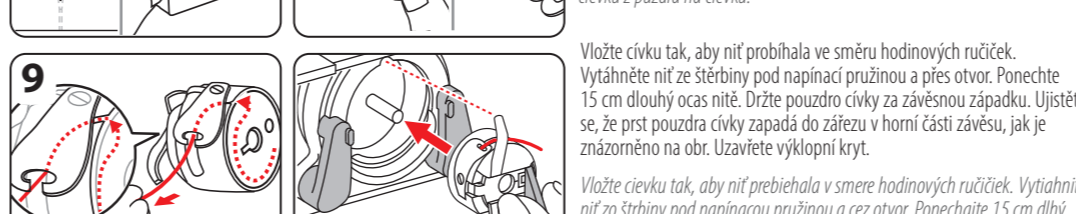
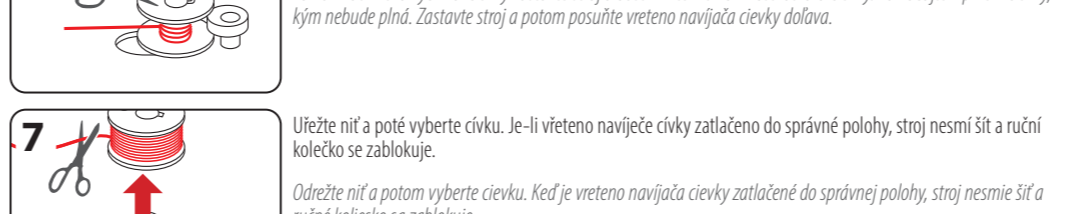
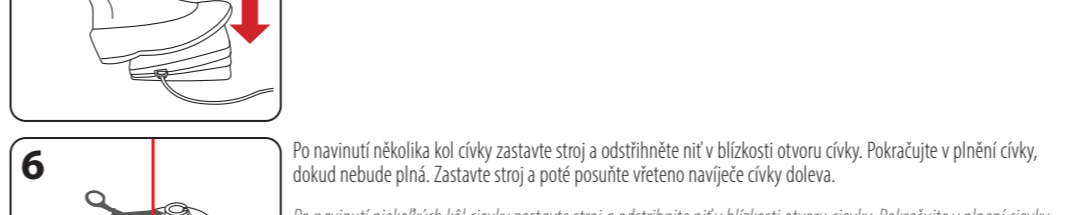
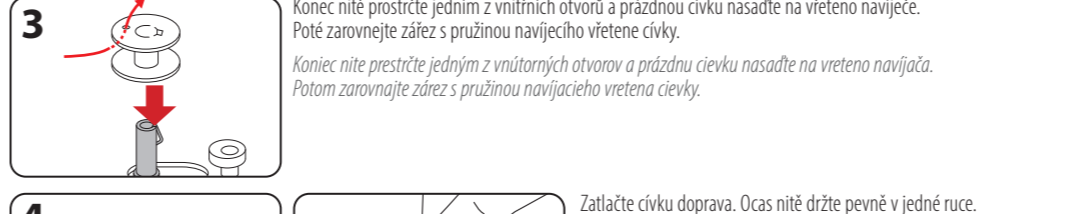
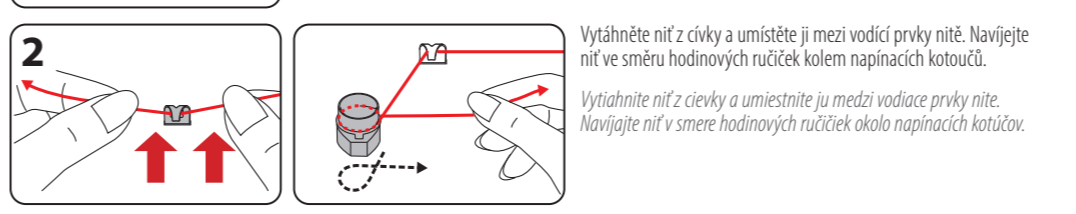
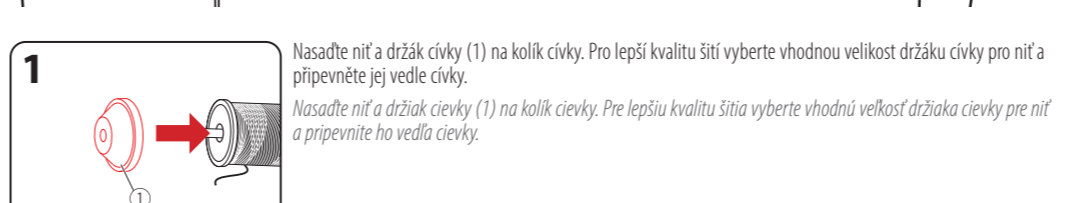
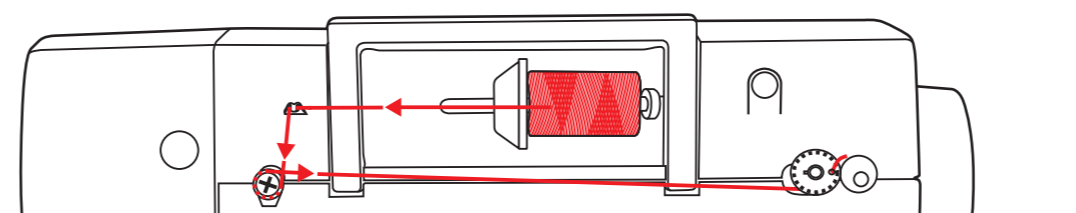

Navlékání horní nitě Navliekanie hornej nitě

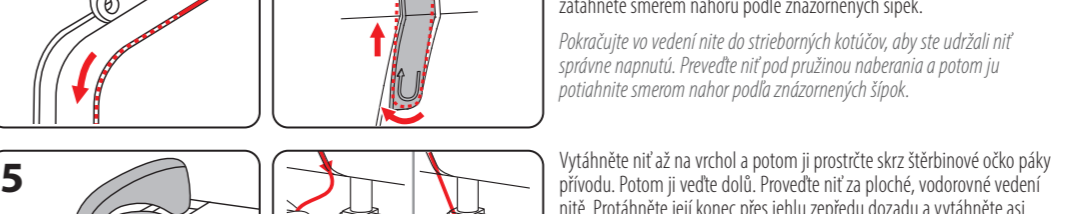
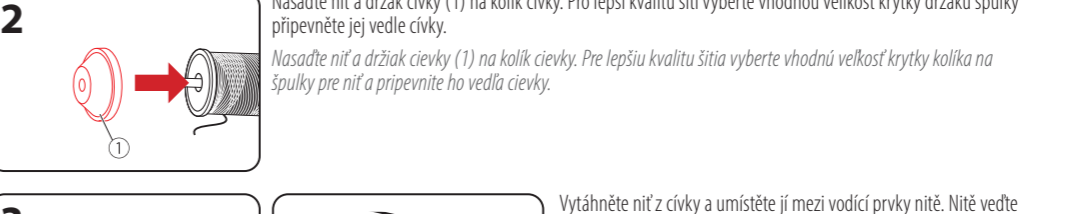
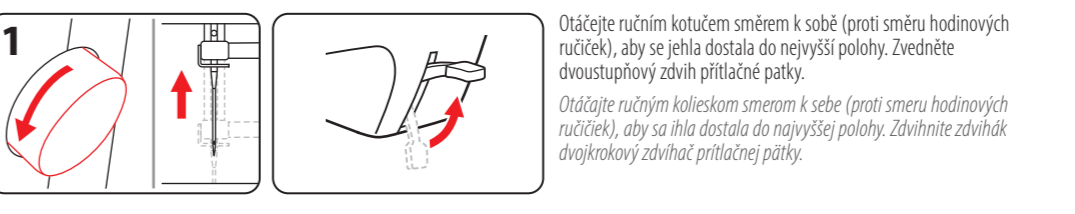
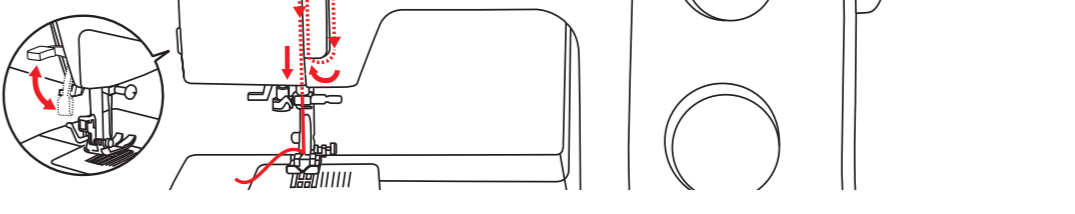
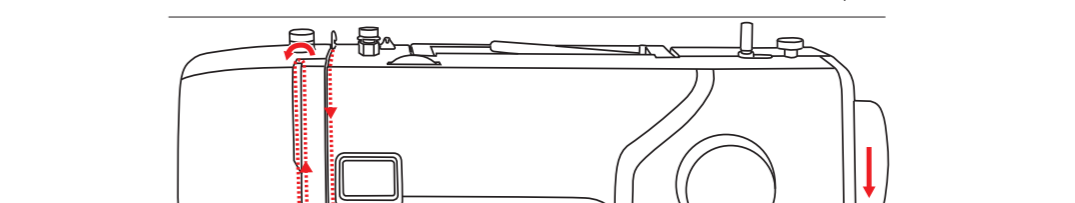
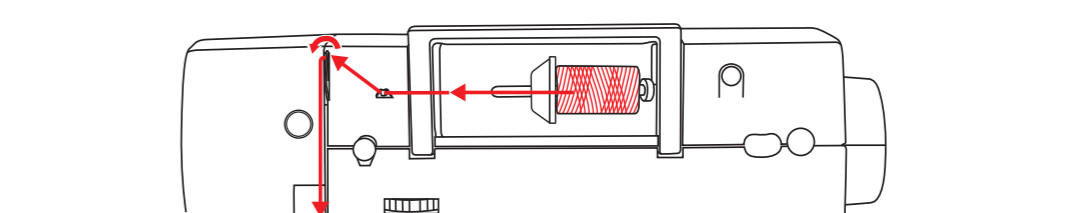

Začínáme šít Začiatok šitia

